

# EUROPE'S BEST-IN-CLASS DECKING

- Award winning design
- Outstanding performance
- Uniquely sustainable
- Great value

# UPM ProFi: the decking you can love **four** times more

## for living

award winning design & effortless to maintain

## for life

up to 25-year guarantee, engineered to perform  
& last at home and in commercial applications

## for family

splinter free and superior stain, scratch  
and fade resistance: a deck for all generations

## for our future

A European success story: designed in Finland  
and manufactured in Germany with recycled plastic  
based waste from throughout Europe.

## Contents

Europe's Best in Class Decking.....	4
A uniquely sustainable choice.....	6
Real references from across Europe.....	8
UPM ProFi Piazza Pro & One .....	20
UPM ProFi Deck 150 .....	28
UPM ProFi Click System .....	34
Product Specification Pages.....	36
Technical Support for Installers, Distributors & Architects.....	46
Tips for planning, installation & maintenance .....	49



# Introducing Europe's Best in Class Decking

- Award Winning Design
- Outstanding Performance
- Unique Sustainability
- Great Value

These are the reasons why it is safe to say that UPM ProFi is Europe's Best in Class decking.

A deck should **look great** when you install it: it should still look great **after years** of living, playing, splashing, spilling, wining and dining. You'll need a surface that **resists stains and scratches**, that **holds its colours** over years, that will not swell, crack, break or rot. UPM ProFi decking is guaranteed to perform.

Bare-foot friendly means more than just **splinter free**. A deck should feel **natural to the touch** and yet be **tough enough** to survive the knocks and scrapes of stilettos and boots. (Never mind the furniture, plant pots and barbecue grill.) Since 2007, UPM ProFi has been installed throughout Europe from north of the Arctic Circle to the Mediterranean Sea, in private homes, restaurants and hotels.

**Safety is at the core** of UPM design. Whether carrying a heavy load in the rain or running by a swimming pool, a deck should have a **non-slip surface** whether wet or dry.

You want a deck that will not rot, but that is also **free of toxic chemicals**. A deck that passes the European standard for Toy safety. A deck that is PVC free and from which any off-cuts generated during installation can be safely disposed off with normal household waste.

**True sustainability**: many claim it: few live by it. A lot of composite and timber decking is shipped thousands of kilometers to Europe from the other side of the world. Others are made in Europe by mixing sawdust and plastic. We do better. **We take Europe's waste**, its old shampoo and detergent bottles, its paper and plastic label waste and use it to **make in Germany great new European products** that can be recycled again.

If you are a professional installer, you know **the value of good design**. UPM ProFi decking is a **total system**: developed to be installed quickly, to last decades, and with features that enable a professional finish.

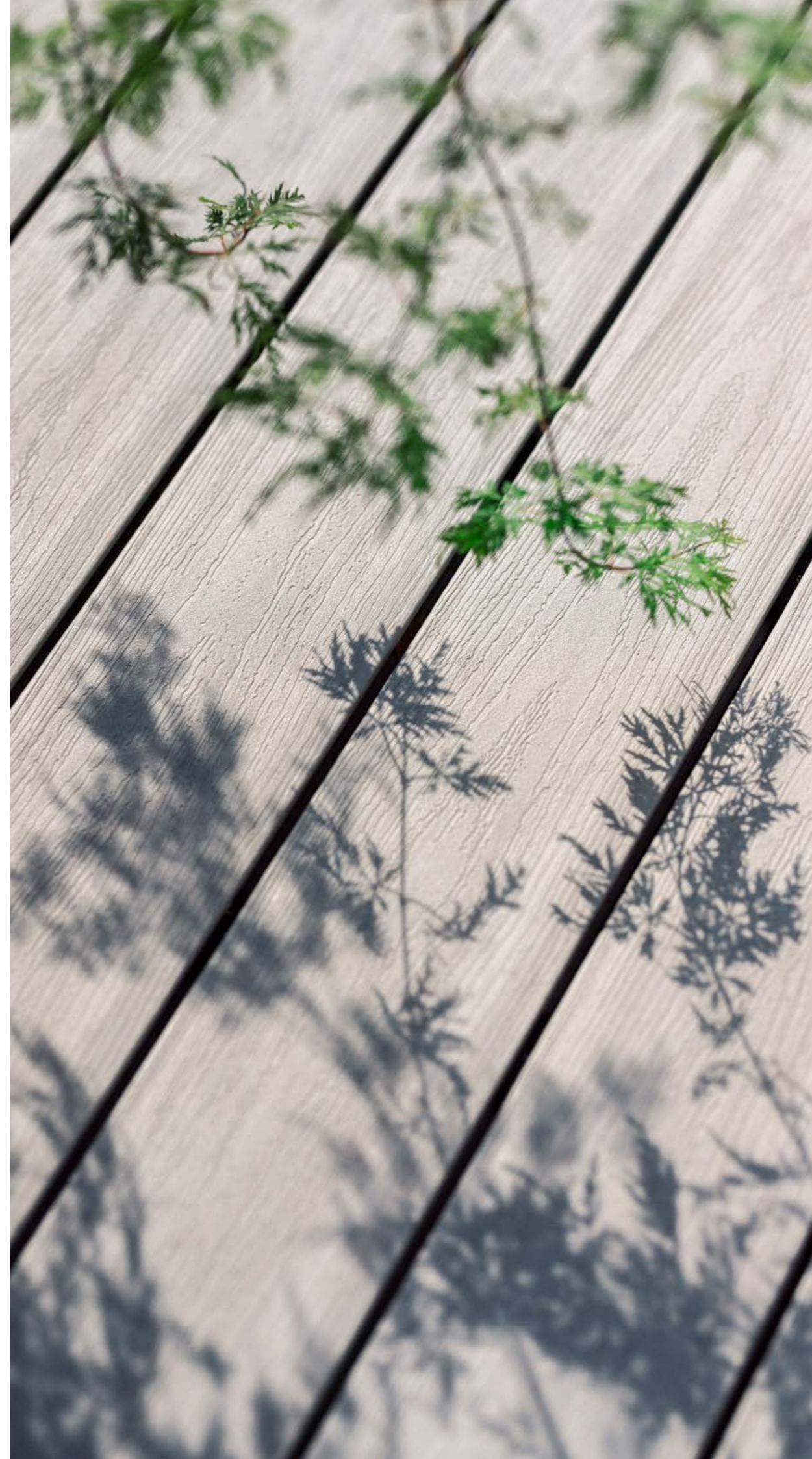

## Up to 25 years guarantee:

- Stain resistance
- Colour durability
- Structural integrity

## Superior performance

- Class leading colour durability & stain resistance
- Splinter free
- Enhanced scratch & impact resistance
- Non-Slip: wet or dry: >36 EN15676

## Smart Installation

- Zero degree incline
- Patented Click System saving typically 60% installation time
- Unique Rail-Step for stairs & edges

## Uniquely Sustainable

Made in Germany with up to 75% recycled post consumer & post industrial plastic based waste sourced from France, Germany, Italy, Netherlands, Poland & UK

- 100% Recyclable
- Carbon footprint minimized through local European logistics
- PVC free & EN-71-3 Standard for Toy Safety compliant

## Independently Assessed

- PEFC Chain of Custody
- ISO 9001 Quality Management
- ISO 14001 Environmental Management
- ISO 50001 Energy Management



Please see product pages for specific details concerning each product and application.

# A uniquely sustainable choice

## Sophisticated recycling technology bringing new life to Europe's plastic & label waste

We take Europe's plastic and label waste and utilize state of the art material science and production technology to create new high performance products. We don't do this because it is easy: we do it because it is important, even though it adds costs to our production processes.

The paper fibres found in label waste are an excellent alternative to wood fibres found in normal composite decking. And by recycling Europe's plastic containers, we can prevent waste being landfilled, incinerated or ending up in the oceans.

To ensure that our decking products achieve best in class performance, we do use the best available colour pigments, UV stabilizers and other additives. However, these are always compliant with the EU Public Health and Environment legislation. (REACH) and our decking has been certified as compliant with the European Standard applicable for materials used in toys: safe for the environment: safe for the family.



## Part of a company that is independently recognized as a front runner in sustainability

UPM ProFi is part of UPM, one of the world's leading producers of renewable & recyclable products. UPM is independently recognized as being at the forefront of companies in the areas of sustainability and corporate governance. The company's headquarters are in Finland, it employs 17 000 persons and operates 54 production plants across 46 countries, UPM is committed to creating a future beyond fossils.



## Helping to build Europe's Circular Economy

Recycled waste plastic and label materials are sourced from throughout Europe and given a new life through the manufacture of UPM ProFi decking in Bruchsal, Germany. By choosing UPM ProFi, together we can be part of the solution to create Europe's Circular Economy.

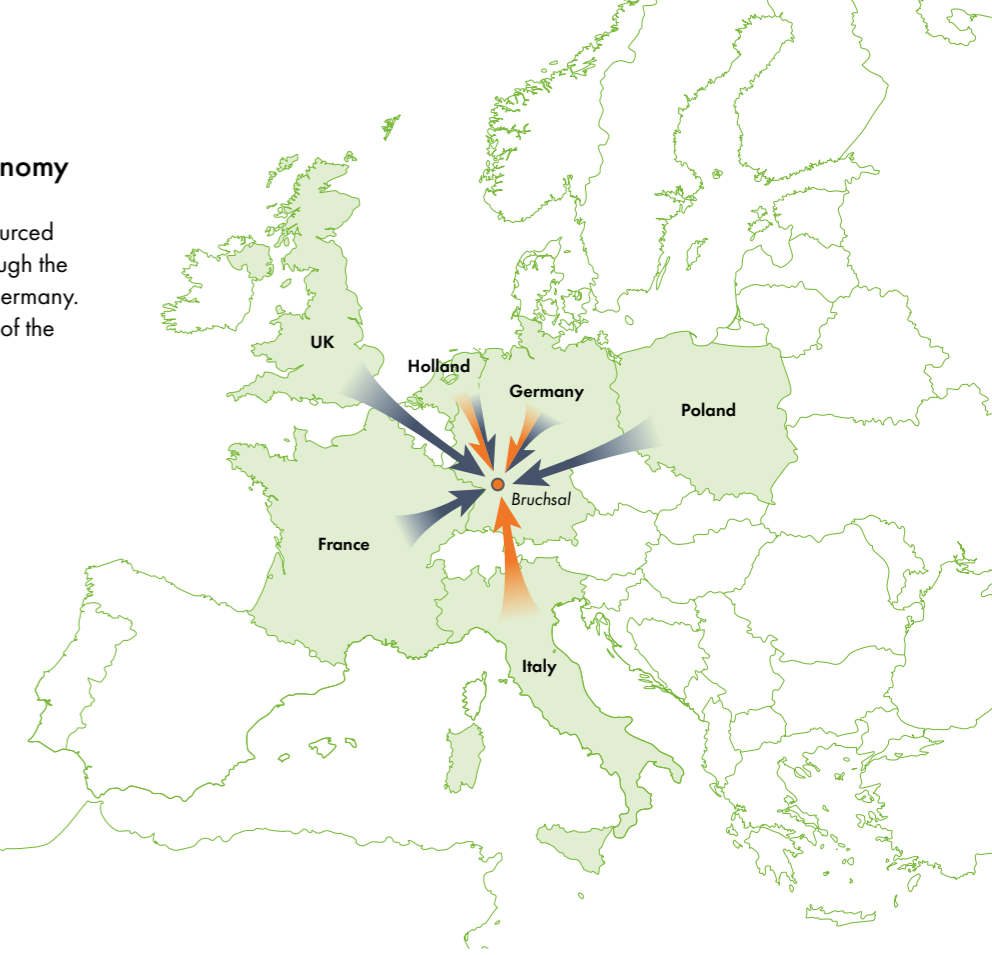

Every UPM ProFi Piazza binds CO<sub>2</sub> that would be released if the waste was incinerated

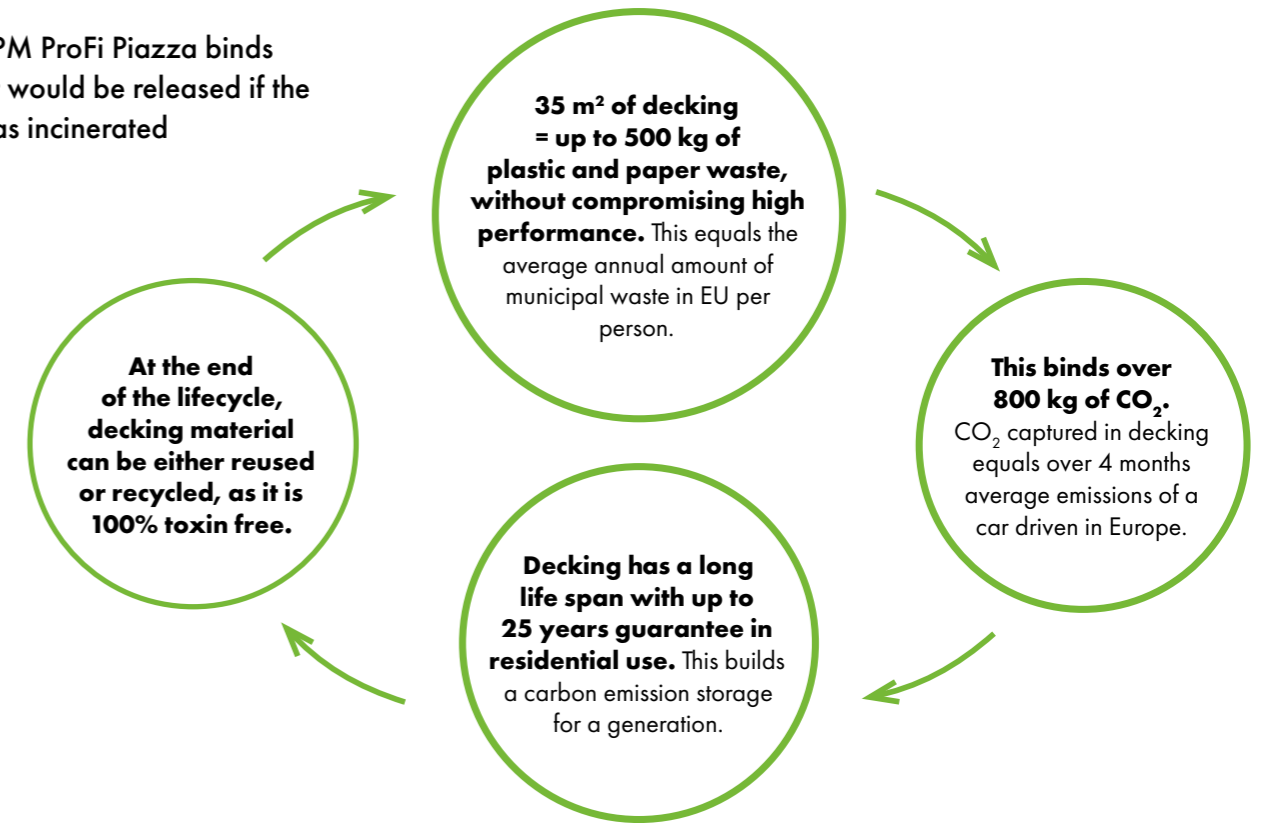

We reduce the world's reliance on fossil-based materials by developing renewable and responsible products and solutions in all our businesses.  
**UPM Biofore – Beyond fossils.**

# CASE: Family + Nature = Harmony

Naantali is a magical land at the south-western most point of Finland. (It is also the home of Moominworld). Here it is that **Harri Tikkanen** and his family have built a home that is a showcase for the best of Nordic design. Villa Myötätuuli, meaning fair wind, has been designed to be in harmony with its surrounding nature and yet at the same time be the perfect family home.

For the Finns, outdoor living is in their blood. At the height of summer in Naantali the sun rises shortly after 4 am and sets at 11 pm. It was clear for Tikkanen family that the decking areas would be more like an outdoor living room. And yet, with high rainfall and temperatures sinking to below -20 degrees Celsius in winter, the building materials could only be of the highest quality.

Villa Myötätuuli has two deck areas as well as first floor balconies opening from the bedrooms. Indoor and outdoor areas merge seamlessly: part of the deck area is even glazed for all year usage. UPM ProFi Piazza has been installed in all these areas.

*"We chose UPM ProFi Piazza based on recommendations from other homeowners" says Harri. "Ease of maintenance, reliable quality and the beautiful Nordic Ash light grey colour were also key factors in our decision".*

Villa Myötätuuli featured in the 2022 Naantali Housing Fair, in which the latest building innovations are showcased. A sustainable approach was one of the foundations to the whole fair, with homes, streets and services all designed to blend in with surrounding cliffs, fields and forests. However, first and foremost is Villa Myötätuuli a family home and the deck an area to be lived on. Neither splashes from the hot tub, nor spills from the barbecue area will leave any stain on UPM ProFi Piazza. A final word from Harri: *"We wanted the terrace to be an integral part of our family life. We can have our morning coffee on the terrace, the children can play there during the day and in the evening we can have a barbecue and go to the hot tub to enjoy the bubbles".*



## CASE: Beach holiday at home

Already blessed with stunning mountain views, the Tetu family had one more ambition for their home.

Situated in the heart of the French alps, Albertville is world famous for winter sports. (In 1992 the winter Olympics were held there). However, for local resident **Patrice Tetu**, it is the long hot summer days that are to be enjoyed outside. On one side of their house, overlooking the garden, they have a terrace where they can admire the mountains while they dine. On the other side is the swimming pool where they can also admire the mountains while they relax.

*"The goal was to be able to enjoy the pool in the summer as though we were at the beach"* explained **Mr. Tetu**. His wife is also a fan of the outdoor life.

*"A typical day when I spend time on the terrace is when the sun is out, it's warm and I can enjoy the light. My dream day on the terrace consists of a deck chair, a parasol and swimming up and down the length of the pool"* describes **Madame Tetu**.

The Tetus chose UPM ProFi Piazza One Silver Teak based on the design and the low maintenance properties. Having a non-slip surface whether wet or dry, and being resistance to stains, including chlorinated water, the deck was perfect for the poolside.



The 110m<sup>2</sup> deck is guaranteed against stains, colour fading and structural defects for 25 years.

While UPM ProFi decking is usually installed by a professional installer, in this case Mr. Tetu planned and installed the deck himself. The whole process from initial idea, through planning the deck, sourcing the materials and installing them took eight months.

UPM ProFi's Deck Planner enables you to visualize your deck and obtain a full materials list and sub-structure design.

One final piece of advice from M. Tetu: *"Be sure to follow the installation instructions"*.





## CASE: The expert's home choice

Imagine spending your working life devoted to satisfying others as a restaurant owner: finding the best ingredients, building the team with the right expertise, creating the perfect atmosphere, and managing the whole thing as business. When it comes to your own home: that needs to be special.

In his professional life, **Andy Solomon** is the founder and owner of both the Treffi pub and bistro, and the Fat Lizard restaurant chain. When planning the materials to be used in his own home, Andy was looking for the same high quality of design, performance and ease of maintenance that he would choose for his restaurants.

The home is a beautiful apartment situated in Helsinki's Kalasatama harbour which was completed in the autumn of 2021. The L-shaped balcony offers stunning views of both the sea and the city. Part of the area is enclosed with glass paneling making it an outdoor living area that can be enjoyed whatever the weather. Having had good experience with UPM ProFi decking at his previous home, Andy knew that it would be the perfect material for the new balconies. UPM ProFi Piazza Pro Californian Oak proved to be the colour that not only matched the

clean and modern design of the apartment but was also in harmony with the natural colours of the sea, the sky and the forest.

When you work long hours, then you want to be able to live on your deck, not spend hours maintaining it. UPM ProFi Piazza's surface is guaranteed to resist stains and retain its colour for at least 25 years in residential applications and 20 years in harsher environments such as restaurants and other commercial applications. The surface is also highly scratch resistant and is slip resistant whether wet or dry.



The balcony decks were installed with UPM ProFi's award winning and patented Click System. Compared to traditional deck building, the Click System enables typically a sixty percent reduction in time needed for installation. Furthermore, most of the sub-structure components can be pre-assembled off-site, minimizing the time spent at the property.





## CASE: Finest French cuisine + Europe's best decking

Situated at the foot of the Château de la Napoule on the French Riviera, Le Boucanier is famed for its excellent seafood and glorious location. Throughout the summer, tables on its open terrace just a few meters from the beach are in high demand from both locals and tourists.

With salt and sand in the sea breeze, furniture and high heels scraping across the deck boards, and oil and wine being spilt, the **Chaumier** family were looking for an exceptionally durable surface for their restaurant outdoor area. In such a stunning location, the look and design of the deck was equally important.

**Valérie Giusta** is the branch manager of the wood materials' distributor Dispano Le Cannet. Understanding the needs of Le Boucanier, she was able to recommend UPM ProFi Piazza Pro for the restaurant. UPM ProFi deckings are made in Europe (Germany) from recycled plastic and label waste materials sourced from across Europe (including France).

**Mr. Ave**, the manager at FAVE, the company chosen to install the decking at Le Boucanier, "It is easier to install UPM ProFi Piazza boards than the more challenging, shorter and less stable Ipé tropical hardwood boards. You just have to follow the installation instructions carefully as the installation of wood composite boards differs slightly from the installation of exotic wood or treated pine boards."

Together with their architect, the owners of the restaurant selected the colour Californian Oak as best fitting to both the restaurant design and the surrounding environment.

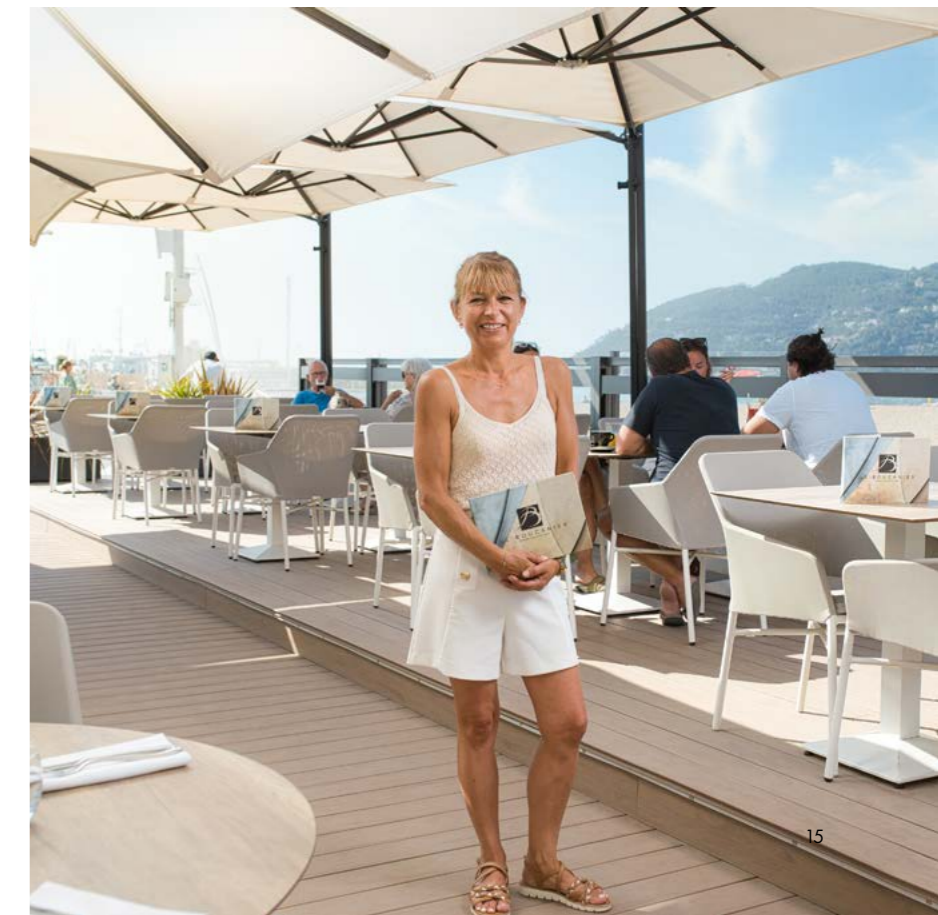



# CASE: Sustainable design in architecture



*“Sustainable choices bring long lasting solutions that people can be proud of”, says Architect and Partner **Stefan Blach**, from Studio Libeskind, New York who has been in charge of the huge Nokia Arena and Residential Towers project. The ambitious urban renewal at the heart of Finland’s second largest city, Tampere, includes 82 000 m<sup>2</sup> of buildings: an ice hockey arena, a hotel, and five residential towers.*

The project stitches the urban fabric back together across an existing railway and connects East to West, creating a new vibrant hub of high quality living, working, leisure and culture for the city and Finland. The importance of outdoor living, even in an urban environment, is included in Libeskind’s design.

*“Outdoor spaces, balconies and deckings, play an even more important role nowadays in architecture, as since the pandemic people are really looking for green and safe environments with fresh air, in proximity to their homes and offices”, Blach explains.*

Installed in the residential building’s top floor apartment, UPM ProFi Piazza One is a good example how sustainable design and enhanced outdoor living can be combined. The beautiful decking offers both class leading performance (25 years warranty for colour durability, stain resistance & structural integrity) and is a uniquely sustainable European solution. (made in Germany with 75% recycled plastic based waste sourced from across Europe.)

*“Plastic is a huge problem and the best we can make of it, is re-use it in long lasting construction material, his is a very good solution”, says Blach.*

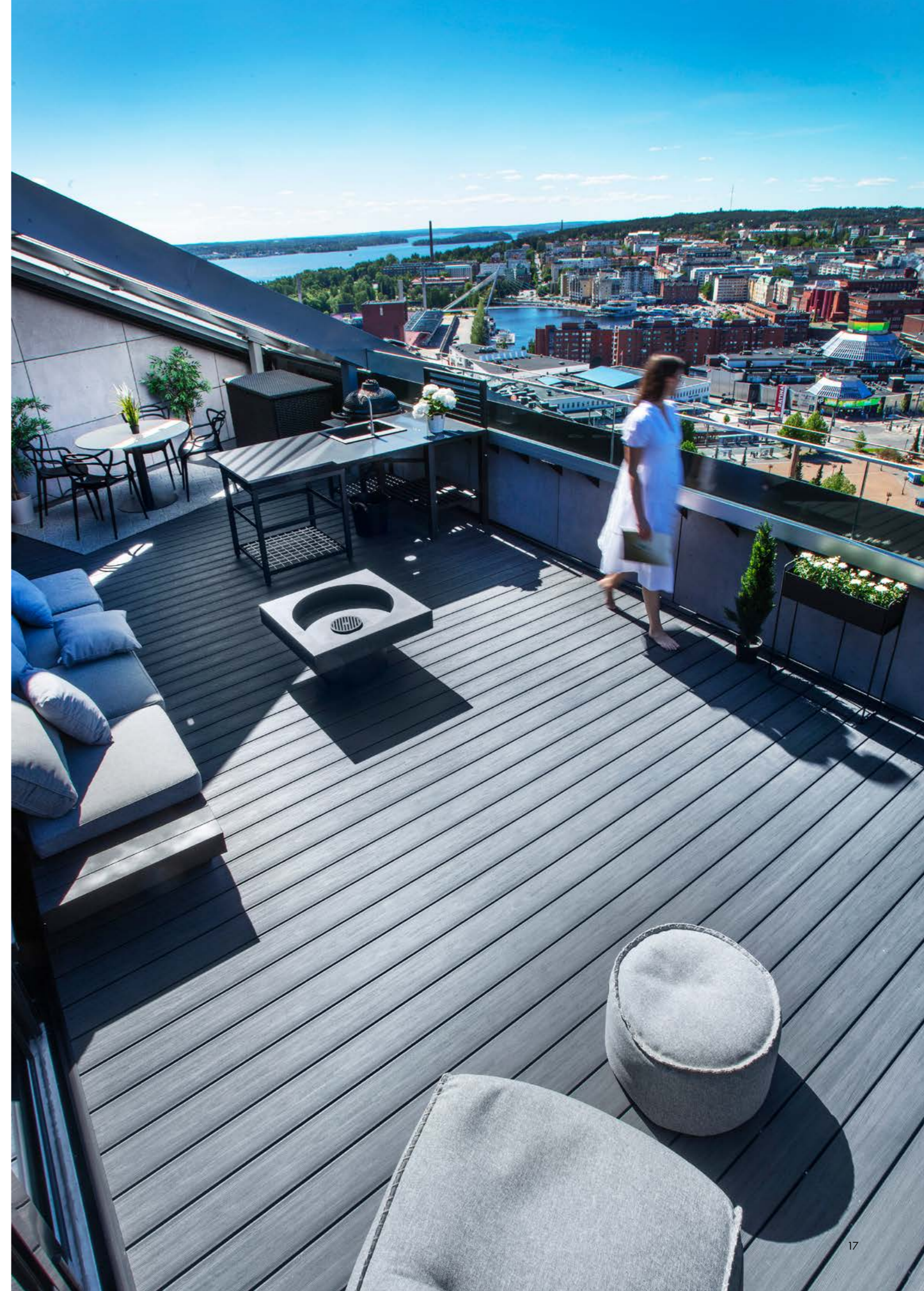



## CASE: Smart installation



After working fifteen years in construction, professional installer **Joey Neve** set up his own business in the Netherlands over five years ago. With projects in both Amsterdam and Zeeland, he has worked with many different construction materials. Concerning UPM ProFi decking Joey says

*"It's a beautiful and well-thought-out product. It's low-maintenance and all of the installation materials are included with the delivery. Details are important and that's why the system also has a number of clever accessories, including a patented solution for steps and rubber strips that make a closed deck surface and prevent dirt from falling through the gaps".*

Since its launch in 2007, UPM ProFi Deck 150 has brought fresh and modern design to outdoor living throughout Europe. Its range of smart accessories ensure a professional finish.



# UPM ProFi Piazza Pro & One

Europe's best in class composite decking with a natural hardwood look



Nordic Ash



Silver Teak



Royal Elm



Californian Oak



Brazilian Walnut



Streaked Ebony

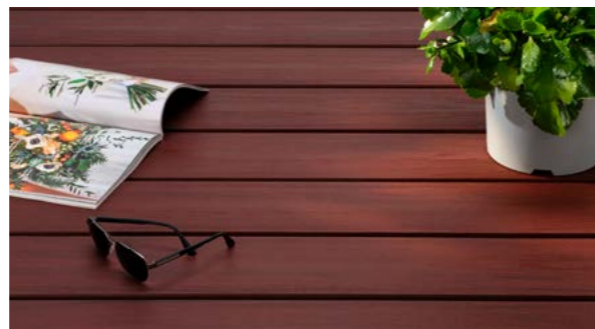

Red Padouk





### 25 year residential & 20 year commercial guarantee covering

- Stain resistance
- Colour durability
- Structural integrity

### Superior performance

- Class leading colour durability & stain resistance
- Splinter free
- Enhanced scratch & impact resistance
- Non-Slip: wet or dry: >36 EN15676

### Smart Installation

- Zero degree incline installation possible
- Can be installed with either hidden T-Clip or patented Click System saving typically 60% installation time
- Flexible Cover Strip available for deck edges
- Alu Rails & Rubber Strip for closed deck solutions

### Uniquely Sustainable

- Made in Germany with up to 75% recycled post consumer & post industrial plastic based waste sourced from France, Germany, Italy, Netherlands, Poland & UK
- Products that are recyclable
- Carbon footprint minimized through local European logistics
- PVC free & EN-71-3 Standard for Toy Safety compliant

### Independently Assessed

- ISO 9001 Quality Management
- ISO 14001 Environmental Management
- ISO 50001 Energy Management
- PEFC Chain of Custody



25 x 140 mm  
Length: 4 m



## UPM PROFi PIAZZA PRO

### For commercial and residential applications

The ultimate low maintenance high performance composite deck available in seven beautiful variegated colour shades. The full 360 degree high performance cross-linked polymer shell is unbrushed and offers best in class colour durability, stain resistance and scratch resistance. The ultra-durable core is made 75% recycled European plastic & label based materials and has exceptional moisture absorption resistance ensuring a long life.

UPM ProFi Piazza Pro is produced with a natural looking hardwood grain that is barefoot friendly, hard wearing and offers a good anti-slip surface whether wet or dry.

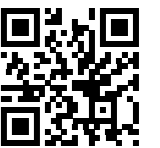



# UPM PROFI PIAZZA ONE

## For residential applications

UPM ProFi Piazza One is manufactured with the same core and surface materials as Piazza Pro. The lighter profile is designed for residential use only. The unbrushed high performance cross-linked polymer shell offers best in class colour durability, stain resistance and scratch resistance. The boards' ultra-durable core are made with 75% recycled European plastic & label based materials and have class leading moisture absorption resistance ensuring a long life.

UPM ProFi Piazza One is produced with a natural looking hardwood grain that is barefoot friendly, hard wearing and offers a good anti-slip surface whether wet or dry.



### 25 year residential guarantee covering

- Stain resistance
- Colour durability
- Structural integrity

### Superior performance

- Class leading colour durability & stain resistance
- Splinter free
- Enhanced Scratch & impact resistance
- Non-Slip: wet or dry: >36 EN15676

### Smart Installation

- Zero degree incline installation possible
- Installed with hidden Wing Clip
- Flexible Cover Strip available for deck edges
- Alu Rails & Rubber Strip for closed deck solutions

### Uniquely Sustainable

- Made in Germany with up to 75% recycled post consumer & post industrial plastic based waste sourced from France, Germany, Italy, Netherlands, Poland & UK
- Products that are recyclable
- Carbon footprint minimized through local European logistics
- PVC free & EN-71-3 Standard for Toy Safety compliant

### Independently Assessed

- ISO 9001 Quality Management
- ISO 14001 Environmental Management
- ISO 50001 Energy Management
- PEFC Chain of Custody



25 x 140 mm  
Length: 4 m



UPM ProFi Piazza Pro or One on UPM ProFi **Support Rail (composite)**: ground level applications only



- |   |   |
|---|---|
| Fixing options  | <b>1 Piazza Pro or One Deck Boards</b><br>available in seven natural hardwood colour shades. Slight difference between Piazza Pro & Piazza One colours may exist.   |
|   | <b>2 Cover Strip</b><br>enabling straight or even curved deck edges. There is a slight difference between the deck board and cover strip colour shades.   |
|   | <b>3a Wing Clip (Piazza One), T-Clip or Click-Clip (Piazza Pro)</b><br>"hidden" clips allowing fast installation and de-installation of deck boards, allowing normal thermal expansion and contraction. Start Clips available for all boards.   |
|   | <b>3b Alu Rail (alternative to clips)</b><br>provides closed and easy to clean deck surface: additional ventilation points needed.  |
|   | <b>4 Support Rails: Composite, Aluminium, &amp; Click-System</b><br>UPM ProFi Support Rail (composite) may be used for ground level installation on hard flat surfaces only. UPM ProFi Alu Support Rail Small also for ground level installation on hard flat surfaces only where minimal installation heights exist. UPM ProFi Alu Support Rail Large & Click Alu Support Rails are designed for raised decks. Standard support rail spacing for Piazza Pro is 40 cm (Residential) and 30 cm (Commercial), and for Piazza One 35 cm. |
|   | <b>5 Rubber Strip</b><br>for closed yacht type deck surface. Eliminates static discharge that may occur on insulated decks (eg roof terraces) Additional ventilation points needed.   |
| <b>6 Foot (Large/Medium/Small)</b><br>For raised decks with UPM ProFi Alu Support Rail Large or Click Alu Support Rail. |   |

UPM ProFi Piazza Pro or One on UPM ProFi **Alu Support Rail Large**: suitable for raised decks



UPM ProFi patented **Click System** for UPM ProFi Piazza Pro: suitable for raised decks: **typically 60% faster** installation



- |                           |
|---------------------------|
| <b>7 Click Start Clip</b> |
| <b>8 Direct Fix Clip</b>  |
| <b>9 Corner Piece</b>     |



## UPM ProFi Deck 150

Europe's Best in Class composite decking bringing fresh design to outdoor living



Stone Grey

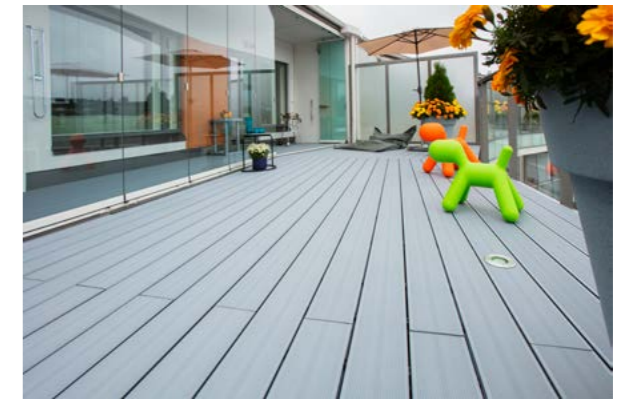

Pearl Grey



Night Sky Black



Autumn Brown

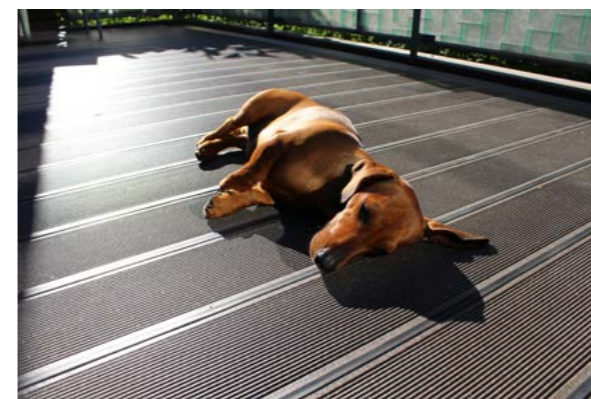

Chestnut Brown



Silver Green

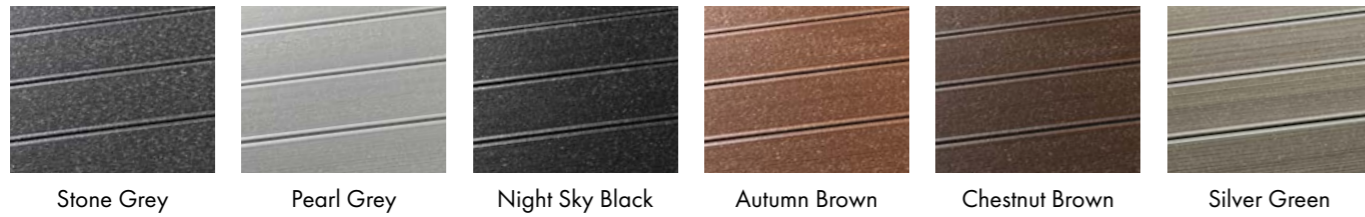

# UPM PROFI DECK 150

## For commercial and residential applications

With its pure Nordic design and outstanding performance properties, UPM ProFi Deck 150 enables a fresh and clean approach to outdoor living. Stone like in appearance, the boards have a natural feel and long lasting durability. The non-brushed reversible surface has exceptional stain resistance properties and the engineered profile has class leading moisture resistance and impact strength properties.

Good design is at the heart of the UPM ProFi Deck 150 system with its unique Rail Step profile for stairs and edges, its end caps with a patented locking system, a cover strip that is flexible enough to allow curved decks, and its aluminium and rubber solutions for a closed deck.



### 10 year residential & 5 year commercial guarantee covering

- Structural integrity

### Superior performance

- Superior stain resistance: non-brushed surface
- Natural weathering resulting in limited colour fading over time
- Splinter free
- Enhanced scratch & impact resistance
- Class leading impact resistance
- Non-Slip: wet or dry: >36 EN15676

### Smart Installation

- Zero degree incline installation possible
- Can be installed with either hidden T-Clip or patented Click System saving typically 60% installation time
- Unique Rail Step for professional stairs & edges
- Flexible cover strips enabling curved edges
- End caps with patented locking system

### Uniquely Sustainable

- Made in Germany with up to 55% recycled post industrial plastic based waste sourced from France, Germany, Poland & UK
- Products that are recyclable
- Carbon footprint minimized through local European logistics
- PVC free & EN-71-3 Standard for Toy safety compliant

### Independently Assessed

- ISO 9001 Quality Management
- ISO 14001 Environmental Management
- ISO 50001 Energy Management
- PEFC Chain of Custody



25 x 150 mm  
Length: 4 m





UPM ProFi Deck 150 on UPM ProFi **Support Rail (composite)**:  
ground level applications only



**1 Deck Boards**  
available in a range of 6 colours.

**2a Rail Step**  
the patented solution for fast and professional staircases, deck & pool edges.

Edging  
options

**2b Cover Strip**  
enabling straight or even curved deck edges.

**2c End Caps**  
closes deck boards' hollow chambers with a patented locking system.

Fixing  
options

**3a T-Clip or Click Clip**  
fast installation and de-installation of deck boards, allowing normal thermal expansion and contraction.

**3b Alu Rail**  
provides closed and easy to clean deck surface, creates an even stronger structure for tough applications: additional ventilation points needed.

**4 Support Rail**  
UPM ProFi Support Rail (composite) may be used for ground level installation on hard flat surfaces only. UPM ProFi Alu Support Rail Small also for ground level installation on hard flat surfaces only where minimal installation heights exist. UPM ProFi Alu Support Rail Large & Click Alu Support Rails are designed for raised decks. Standard support rail spacing for Deck 150 is 40 cm (Residential) and 30 cm (Commercial).

**5 Rubber Strip**  
for closed yacht type deck surface. Additional ventilation points needed.

**6 Foot (Large/Medium/Small)**  
for raised decks with UPM ProFi Alu Support Rail Large or Click Alu Support Rail.

UPM ProFi Deck 150 on UPM ProFi **Alu Support Rail & Feet**:  
Suitable for raised level applications



UPM ProFi patented **Click System** for UPM ProFi Deck 150  
Suitable for raised level applications: **typically 60%  
faster installation**

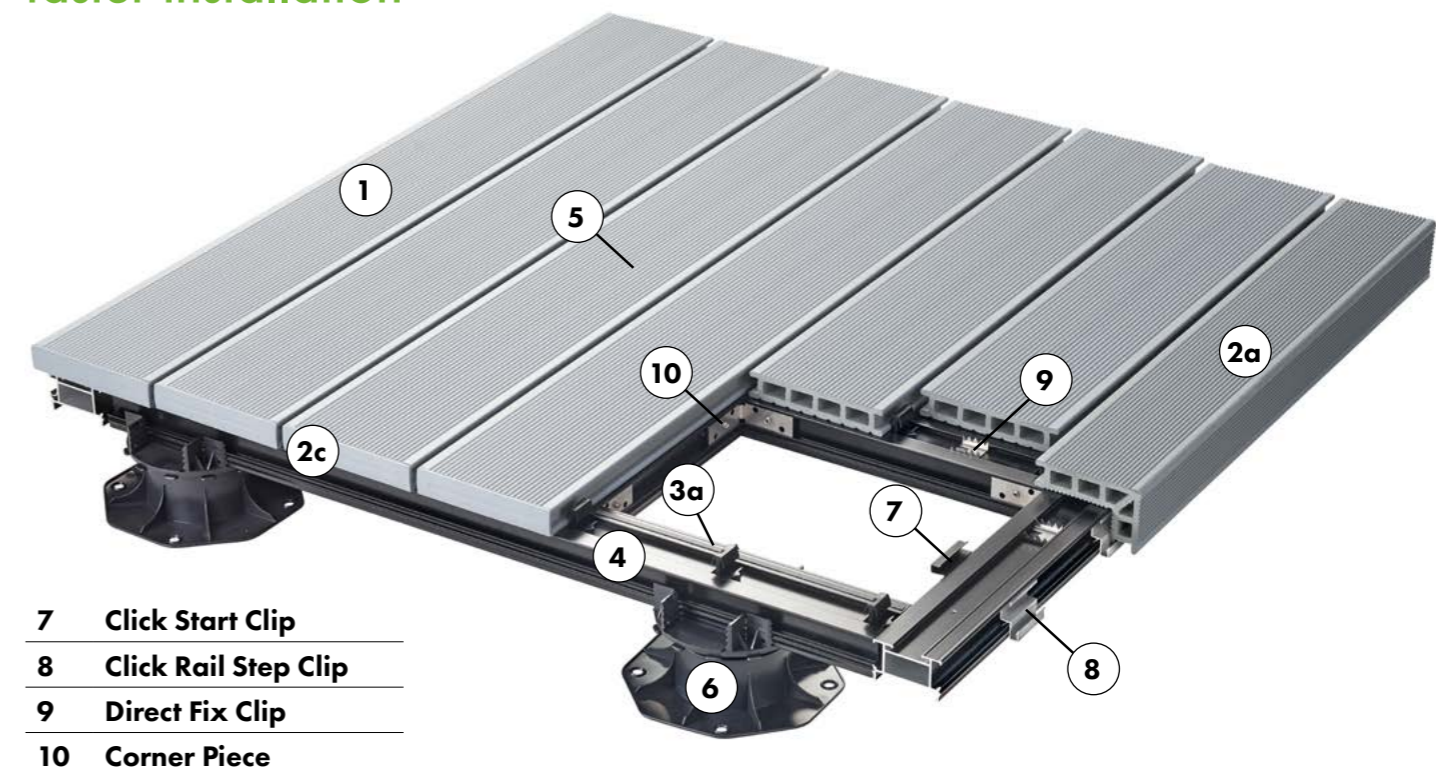

**7 Click Start Clip**

**8 Click Rail Step Clip**

**9 Direct Fix Clip**

**10 Corner Piece**

# UPM ProFi Click System

Typically 60% faster than traditional installation  
Pre-assembly at workbench height saving

- backs and knees
- on-site time

No pre-drilling or screws needed

1 installer  
can build  
10 m<sup>2</sup> deck  
in 1 hour



Fast and ergonomic installation system for professional use



1. Click the clips into the rails



2. Build the sub-construction frame with corner piece



3. Click the feet onto the rails



4. Click the deck boards onto the frame

Full component specification can be found at [www.upmprofi.com/click-system](http://www.upmprofi.com/click-system)

Always follow the full instructions



# UPM PROFI DECK BOARDS

## OVERVIEW

### Piazza One, Piazza Pro, Deck 150, Terra 127



**The Best in Class UPM ProFi composite decking products feature:**

- Easy to clean, stain resistant, lower maintenance WPC decking
- Non-brushed barefoot friendly surface
- From 10 up to 25 years guarantee
- Applicable for demanding commercial sites as well as homes and gardens
- Produced from 55 up to 97 % recycled European plastic & fibre materials
- On the ground, in the ground and underwater installation

#### PRODUCT DATA

	Piazza One	Piazza Pro	Deck 150	Terra 127
Length, m	4, 5*	4, 5*	Deck 150: 4, 5*, 6*	3.15*
Pallet size, pcs	49	49	84	88

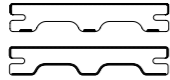
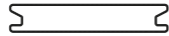
#### MATERIAL REQUIREMENTS per m<sup>2</sup> (approximate needs for residential use)

	Piazza One	Piazza Pro	Deck 150	Terra 127
				
Dimensions, mm	25 x 140	25 x 140	28 x 150	28 x 127.5
Decking Boards, lin m	7	7	6.5	7.5
Support Rail, lin m	3.4	3	3	3.4
Fixing Screw	1 pc per deck board			

#### Installation with Click System: no screws or tools needed

Click Clips, pcs	not possible	18 Click Clips	17 Click Clips	not possible
------------------	--------------	----------------	----------------	--------------

#### Installation with Clips

Clips incl. Screws, pcs	20 Wing Clips	18 T-Clips	17 T-Clips	22 T-Clips
-------------------------	---------------	------------	------------	------------

#### Installation with Alu Rail

Alu Rail, lin m	7	7	6.5	7.5
Screws for Alu Rail, pcs	20	18	17	22
Clips	with Alu Rail installation no clips needed			

#### Optional Components

Start Clip	as required	as required	as required	as required
Rail Step	not possible	not possible	as required	not possible
Cover Strip	as required	as required	as required	as required
Rubber Strip, lin m	7	7	6.5	7.5
Rubber Pad	as required	as required	as required	as required

\* Made to order

#### JOIST SPACING, cm

	Piazza One	Piazza Pro	Deck 150	Terra 127
Residential	35	40	40	35
Commercial	-	30	40	-
High altitudes Residential	35	40	T-Clip: 30 / Alu Rail: 40	-
Commercial	-	30	Alu Rail: 40	-
Hot countries Residential	-	-	T-Clip: 30 / Alu Rail: 40	-
Commercial	-	-	Alu Rail: 40	-







#### GUARANTEE

	Piazza One	Piazza Pro	Deck 150	Terra 127
	Structural Colour durability Stain Resistance	Structural Colour durability Stain Resistance	Structural	Structural
Residential	25 years decreasing	25 years decreasing	10 years full	10 years decreasing
Commercial	-	20 years decreasing	5 years full	-

For full details of UPM ProFi's product warranties please contact your local distributor.

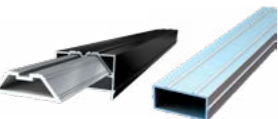
# UPM PROFI ACCESSORIES FOR ALL DECK BOARDS

## UPM PROFI PRODUCT SPECIFICATIONS FOR ALL DECK BOARDS

		Purpose	Material
	<b>Alu Support Rail Small*</b> 23 x 40 mm Length: 1.8 m	extra thin profile for low deck constructions	Aluminium
	<b>Alu Support Rail Large*</b> 45 x 68 mm Length: 4 m	for extra wide spans up to 110 cm	Aluminium
	<b>Connector for Alu Support Rail Large*/</b> <b>Connector for Click Alu Support Rail Large**</b> 32 x 58 / 20 x 43 mm Length: 0.2 m	easy & quick extension of aluminium subconstruction	Aluminium
	<b>Rubber Pad</b> sizes S, M, L 3/8/20 x 60 x 90 mm	for little height adjustments of subconstruction, enabling water to flow under the deck	Rubber
	<b>Rubber Strip</b> 9 x 11 mm Length: 1 box = 50 m	provides closed deck surface & yacht deck look	Rubber
	<b>Foot</b> Small: 35-70, Medium: 65-155, Large: 145-225 mm	easy height adjustment of subconstruction	Plastic

\* Made to Order  
\*\* For installation with UPM ProFi Click System



### UPM ProFi Rubber Pad

- Supports joists if ground is slightly uneven
- Water- and vapor-permeable
  - Enables water to flow under the deck construction
  - Extremely water-permeable rubber granulate (18.000 l/h/m<sup>2</sup>)
  - Rot proof
  - Prolongs life of timber joists

## Subconstruction components



### UPM ProFi Alu Support Rail Large

- The problem solver for extra wide spans up to 110 cm between two supporting feet
- Time and cost-saving installation
  - Fewer feet needed: savings exceed higher price of Alu Support Rail
  - Faster installation: simple and quick click installation to UPM ProFi Foot
- Direct to ground installation possible with Rubber Pads 20 mm inserted

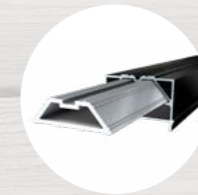

### UPM ProFi Connector for Alu Support Rail Large

- Easy and quick extension by inserting
- Waste-optimized mounting
- Connecting two Alu Support Rails without supporting foot possible



### UPM ProFi Foot

- Click fix to Alu Support Rail Large, screw fixing to timber joists
- Easy and fluid, infinitely variable height adjustment, even when joists are installed
- Flexible in all directions, compensates ground inclinations up to 8%
- Supports up to 1,195 kg per foot
- Rounded foot plate prevents damage to water proof membranes



### UPM ProFi Alu Support Rail Small

- Extra thin profile (23 mm) for low deck constructions
- For minimal installation heights with direct to ground installation
- Built in water-permeable rubber material ensures drainage
- Install directly on hard flat surfaces only



### UPM ProFi Support Rail

- Most economic solution for building deck subconstructions
- Install directly on hard flat surfaces only

# UPM PROFI PIAZZA

## Look & Feel

- Sophisticated & modern
- Natural hardwood style

## Uniquely Sustainable



- Made from 75% recycled post consumer & post industrial European plastic & paper based waste
- 100% recyclable: non-toxic & family safe EN71-3

## Performance

- Up to 25 year stain, fade & structural guarantee for residential use
- 360° high performance shell with Piazza Pro: unbroken at grooves

## Application & Installation

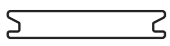
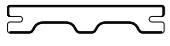
- Residential and commercial use: UPM ProFi Piazza Pro
- Residential use only: Piazza One
- 60% faster installation with UPM ProFi Click System & Piazza Pro

UPM PROFI PIAZZA		Californian Oak	Silver Teak	Brazilian Walnut	Streaked Ebony	Royal Elm	Nordic Ash	Red Padouk
	<b>UPM ProFi Piazza Pro</b> 25 x 140 mm Length: 4 m	●	●	●	●	●	●	●
	<b>UPM ProFi Piazza One</b> 25 x 140 mm Length: 4 m	●	●	●	●	●	●	●
	<b>UPM ProFi Piazza Cover Strip</b> 12 x 66 mm Length: 4 m	●	●	●	●	●	●	●
	<b>UPM ProFi Support Rail</b> 40 x 60 mm Length: 4 m	Colour: Black						

For fixing clips see page 42

● Please check the availability of deck colors with your nearest distributor.



Nordic Ash   Silver Teak   Royal Elm   Californian Oak   Brazilian Walnut   Streaked Ebony   Red Padouk

## UPM ProFi Piazza Pro or Piazza One?

Both decking boards are made with the same high performance surface and ultra-durable core materials. Both are available in the same luxurious colours and have the same high content of recycled European plastic.

With its fuller profile and full 360 degree outer shell, Piazza Pro is stiffer, stronger and has superior dimensional stability: it is simply the best of the best.

	Piazza Pro	Piazza One
Guarantee: structural, fade & stain	25 years	25 years
Zero degree incline installation	Yes	Yes
Residential decks (joist spacing)	Yes (40 cm)	Yes (35 cm)
Commercial decks (joist spacing)	Yes (30 cm)	No
Click System high speed installation	Yes	No

# UPM PROFI DECK 150

## Look & Feel

- Fresh and modern
- Six colour shades inspired by Nordic nature

## Performance







- Full 10 year structural guarantee
- Hollow deck profile, 150 mm wide with high impact resistance

## Sustainability

- Produced from up to 55% recycled European plastic & fibre based materials
- 100% recyclable: non-toxic & family safe EN71-3

## Application & Installation

- Applicable for demanding commercial and residential sites
- Complete system with accessories such as patented Rail Step, colour matching Cover Strips and End Caps
- Installation with T-Clips, Alu Rail or Click System
- 60% faster installation with UPM ProFi Click System for Deck 150 & Piazza Pro

UPM PROFI DECK 150		Autumn Brown	Chestnut Brown	Stone Grey	Night Sky Black	Silver Green	Pearl Grey
	<b>UPM ProFi Deck 150</b> 28 x 150 mm Length: 4 m (5 m + 6 m made to order)	●	●	●	●	●	●
	<b>UPM ProFi Cover Strip</b> 12 x 66 mm Length: 4 m	●	●	●	●	●	●
	<b>UPM ProFi Rail Step</b> 68/28 x 110 mm Length: 4 m	●	●	●	●	●	●
	<b>UPM ProFi Support Rail</b> 40 x 60 mm Length: 4 m	Colour: Black					
	<b>UPM ProFi Deck 150 End Cap</b> 27 x 149 x 23 mm	●	●	●	●	●	●
	<b>UPM ProFi Rail Step End Cap</b> 27/67 x 109 x 23 mm	●	●	●	●	●	●

For fixing clips see page 42

● available   ● made to order   ● subject to availability

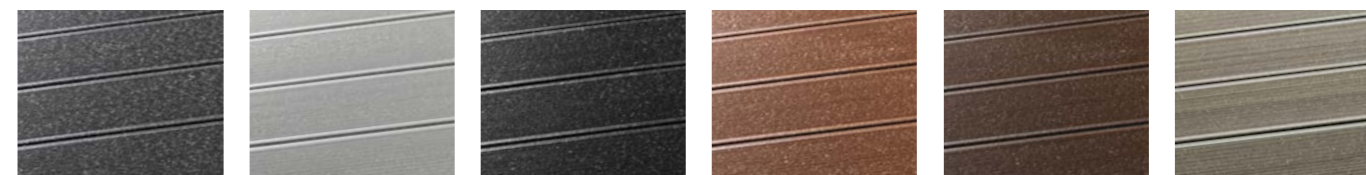

Stone Grey   Pearl Grey   Night Sky Black   Autumn Brown   Chestnut Brown   Silver Green



### UPM ProFi Rail Step

- Fast & professional staircases
- Hard wearing deck and pool edges
- Matches all Deck 150 colours



### UPM ProFi T-Clip







- Fast installation/de-installation of deck boards
- Allows thermal expansion of deck boards
- T-Clip Large allows 90 degree board fixing



### UPM ProFi Rubber Strip

- Provides a typical yacht deck look
- Prevents dirt falling between the deck boards
- Increases surface friction
- Additional ventilation points needed

**FIXING OF DECK BOARDS**

	Purpose and info	Installation gap between deck boards	Material	Amount in box
 <b>T-Clip Small for Piazza Pro, Deck 150, Terra 127</b> 12 x 22 x 45 mm	fixing of deck boards	6 mm	Composite	100 + screws
 <b>T-Clip Large for Piazza Pro, Deck 150, Terra 127</b> 12 x 22 x 63 mm	fixing of deck boards	6 mm	Composite	100 + screws
 <b>Wing Clip for Piazza One</b> 13 x 25 x 30 mm	fixing of deck boards	6 mm	Composite	100 + screws
 <b>Alu Rail for Deck 150</b> 22 x 22 mm Length: 4 m	alternative to clip installation	6 mm	Aluminium	
 <b>Alu Rail for Piazza One</b> 12 x 18 mm Length: 4 m	alternative to clip installation	6 mm	Aluminium	
 <b>Alu Rail for Piazza Pro</b> 12 x 18 mm Length: 4 m	alternative to clip installation	6 mm	Aluminium	
 <b>Start Clip for Piazza Pro, Deck 150, Terra 127</b> 10 x 20 mm	for installation of start and end boards		Steel	50 + screws
 <b>Start Clip for Piazza One</b> 14 x 20 mm	for installation of start and end boards		Steel	50 + screws
 <b>Screw box Large, 115 pcs*</b> 4 x 40 mm	to use with composite or timber subconstruction		A4 Steel	
 <b>Screw box Small, 100 pcs**</b> 4 x 26 mm	to use with Alu Support Rail		A4 Steel	

\* Included in standard T-Clip & Wing Clip boxes

\*\* Included in special T-Clip & Wing Clip boxes for Alu Support Rail



**UPM ProFi Cover Strip**

- Flexible profile enabling straight or curved edges
- Matches all Piazza and Deck 150 colours



**UPM ProFi Alu Rail**







- Provides closed and easy to clean deck surface
- Additional reinforcement for abnormal loads
- Additional ventilation points needed

# UPM PROFI CLICK SYSTEM COMPONENTS

for use with UPM ProFi Deck 150 and Piazza Pro deck boards

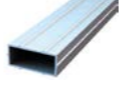
- Ultra-fast click installation: 2.5 times faster than traditional installation
- Sub-construction can be prepared at workbench height, saving backs and knees
- No pre-drilling or screws are needed
- Even pre-fabrication is possible in order to minimize installation time, noise and dirt at customers' site

**UPM PROFI CLICK SYSTEM COMPONENTS**

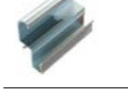
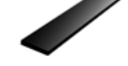
	Purpose	Material
 <b>Click Clip*</b> 27 x 27 x 43 mm	fast and firm installation of deck boards without screws	Plastic
 <b>Click Alu Support Rail for Deck 150*</b> 42 x 68 mm Length: 4 m	with holes drilled every 156 mm for Click Clips, spans up to 100 cm	Aluminium
 <b>Click Alu Support Rail for Piazza Pro*</b> 42 x 68 mm Length: 4 m	with holes drilled every 146 mm for Click Clips, spans up to 100 cm	Aluminium
 <b>Connector for Click Alu Support Rail Large*</b> 20 x 43 mm Length: 0.2 m	waste-optimized, lengthwise connection of support rails	Aluminium
 <b>Corner Piece*</b> 25 x 60 x 60 mm	90 degree connection of support rails	Steel
 <b>Foot</b> Small: 35-70 mm, Medium: 65-155 mm, Large: 145-225 mm	enables raised decks from 35 to 225 mm	Plastic
 <b>Direct Fix Clip*</b> 10 x 28 x 28 mm	makes deck boards stay in position	Steel
 <b>Click Start Clip*</b> 35 x 24 x 50 mm	enables fast installation of first and last deck boards	Aluminium
 <b>Click Rail Step Clip*</b> 38 x 19 x 50 mm	enables fast installation of Rail Step for deck edges	Aluminium
 <b>Quiet Tape*</b> 1 x 6 mm Length: 33 m	dampens sound vibrations	Rubber

\* Made to order



# Designed for **professionals**, robust & fast installation



The UPM ProFi composite decking products have been design for professionals. Whether it is a public or private decking, we recommend using skilled, professional installers for installing the deck boards. Talking about products, we offer a total decking system for robust and fast installation, as well as patented accessories. And talking about skills, we offer training both offline and online for the professional carpenters to ensure high class finish from the grass roots level (sub-construction) to the upper level (decking surface).

Our products are competitively priced and guaranteed up to 25 years. The great looks and award-winning design have satisfied end-customers all over Europe. UPM Biocomposites, the European composite manufacturer, has been in the business for more than 15 years. Recycled plastic and label waste from throughout Europe is given a new long-lasting life. Thus, we are offering Europe's most sustainable decking products.

## Services for installers

**Step-by-step instructions on how to become a professional installer**

<b>Step 1</b>	<b>Step 2</b>	<b>Step 3</b>	<b>Step 4</b>
Send your contact details to us via application form	Join a training session about UPM ProFi Professional Deck Installer Programme	After training, you will receive professional installer certification	Your business contact information will be shared on our web page "Find nearest installer".

[Go to application form](#)



Professional Installer Training



Technical Support in large projects



Deck Planner for planning and visualizing decking before installation



# Local **European** production, local sales & technical support

UPM ProFi is one of the leading composite decking brands in Europe. For over ten years we have led the field with our stain resistant surfaces, attractive look and feel, and reliable performance. By offering both traditional wood look and fresh and modern design look decking, UPM ProFi appeals to the widest range of end customer tastes.

We know that our distribution partners are a vital part of the chain and have developed a full support package to help make sales easy and profitable.

Our dear partners, distributors and retailers, are representing UPM ProFi products which are easy to buy, easy to stock and easy to sell. We operate locally in Europe, with mills in Germany and sourcing of the raw materials being performed mainly in the continent.

Our products have short lead times, and distributors can contact our local sales team as well as technical support. In addition to that, our online services are ever evolving and helping distributors to grow their UPM ProFi sales and business in their markets.



## Services for distributors

### Local sales reps available across Europe

We have a network of key account managers across Europe who are available to provide staff training and technical support whether to the branch staff or your customers.

### Full range of sales promotion tools

A wide range of sales promotional tools including display racks, brochures and sample materials as well as various digital tools.

### Marketing support online

Looking for UPM ProFi marketing materials? Please contact us and ask permissions to our Extranet which contains the following up-to-date information for our customers:

- Latest product flyers and brochures
- High quality reference and product photos
- Guarantee documents
- Video material

### Deck Planner for online planning

Our recently renewed Deck Planner allows customers, installers and end-users to plan their deck and produce a complete specification of materials needed for the project.



# A contemporary material choice, awarded **European design**



Designed and manufactured in Finland and Germany, UPM ProFi products have set new standards in landscape architecture, urban design and garden planning. The composite decking products have been awarded the Green Good Design award and used in several international award-winning architecture design projects.

It is truly a material for our time. A high-performance composite has been manufactured in Europe out of recycled European waste.

Material innovation – called UPM ProFi – was invented in 2005. The new composite offered better colour durability and stain resistance than traditional wpc deckings. Over 60% of the raw material of the new composite could be sourced from self-adhesive label waste. No recycling solution previously existed for this waste.

In decade later, even more options in production were innovated. We are recycling complex paper and plastic streams from both post- and pre-consumer waste.

No short cuts to a circular economy.

### UPM ProFi WPC products

- are recycled and recyclable
- are non toxic
- have a low carbon foot print
- qualify for LEED credits

### Award winning design for outdoor living

Several renowned architects and designers have trusted UPM ProFi wood plastic composite in urban design and other public WPC projects: **Shigeru Ban, Tom Dixon** and **Tobias Rehrberger** have collaborated with us.

With high colour durability, stain resistance and structural integrity guaranteed up to 25 years our products offer best in class properties for decking projects. There is a wide range of sophisticated colour tones and smart installation systems in order to create a professional, rigid and long-lasting finish for the decking.

Awards: German Design Award, Green Good Design etc.  
Services: Large Project Support

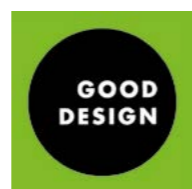
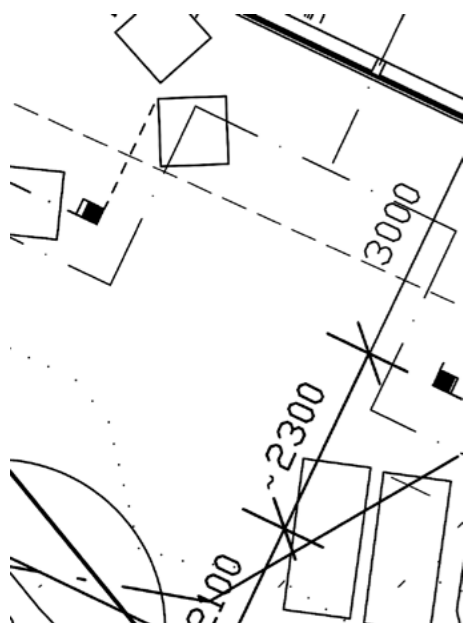

# ALWAYS FOLLOW UPM PROFI'S FULL **INSTALLATION** INSTRUCTIONS

which are available at [www.upmprofi.com](http://www.upmprofi.com) and in the T-Clip and Wing-Clip boxes.

To get the best out of your deck, it is necessary to take into account during installation, that composite decking behaves differently to timber decking. Always follow fully UPM ProFi's installation instructions. Failure to do so may

compromise the performance of your deck and invalidate your UPM ProFi product warranty. The following points are highlighted, but are not to be seen as an alternative to following the full instructions.

1. In all cases, the sub-construction must be formed into a rigid inter-connected frame that will not move, be well ventilated, and be installed so that rain water can easily drain away.

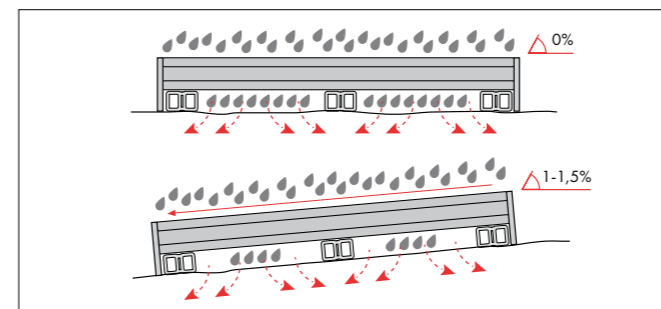

4. The deck should be installed so that the small gaps at the ends where boards meet are part of the design. For example, aligning the boards so that the gap forms one straight line, changing the direction of the boards, or using a framing board installed at a 90 degree angle to the main area.

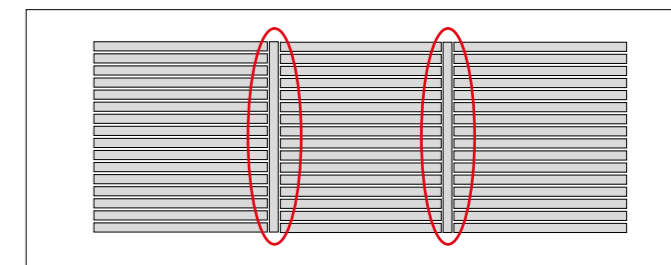

2. UPM ProFi Support Rail and Alu Support Rail Small must only be installed on flat, load bearing surfaces and fixed to the ground at 1m intervals. Raised decks may be built on a rigid frame made with UPM ProFi Alu Support Rail Large and UPM ProFi Feet, or timber (hardwood, durability class 1).

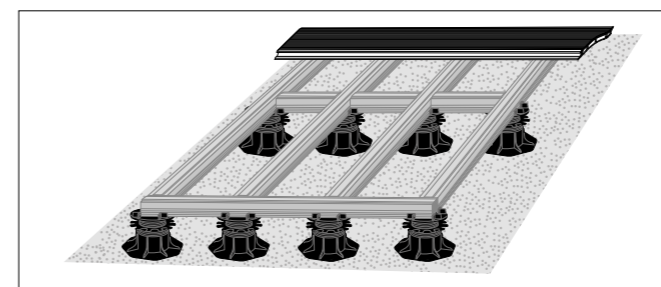

5. UPM ProFi T-Clips, Wing Clips and Alu Rail have all been designed to allow for longitudinal thermal expansion and contraction. To ensure that the boards stay in place and that the gaps are in line, each board should be fixed directly through the board tongue with a screw to the sub-structure.

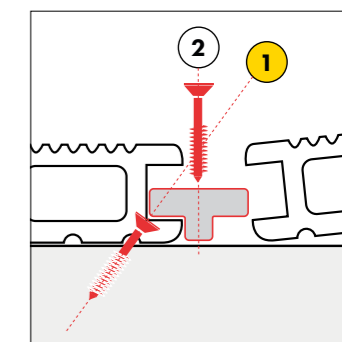

- 1 1x in the middle of each board

3. Composite deck boards have a lower moisture absorption than timber boards and are less prone to swell in wet weather. However they will expand and contract slightly along their length with changes in temperature. It is also normal that the relaxation of residual production stress may result in a small shortening of the deck boards in the first years after installation. Typical values are less than 0,5 mm for Piazza Pro, approximately 1,5 mm for Piazza One & Deck 150 and up to 3 mm per m for Terra 127. If installing in warm weather (deck board temperature above 20°C), no gap should be left at the ends of boards (except Piazza Pro 3 mm gap). If the boards are below 20°C, then a gap of 3 mm should be left for 4 m boards (except Piazza Pro 6 mm gap) and 4 mm for 6 m boards.

6. For joining ends of deck boards, two support rails must be used where they meet. Each board end should be fixed with their own clips. For Piazza Pro and Deck 150 the maximum recommended overhang of a board end is 50 mm, and 30 mm at maximum for Piazza One and Terra 127.

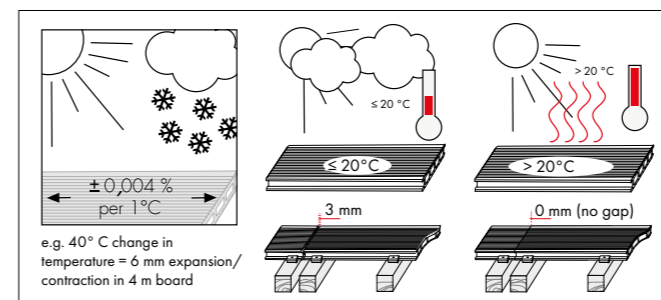
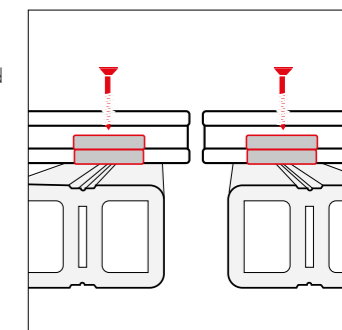

# MAINTENANCE & WEATHERING:

## What to do and expect

### Minimal maintenance

UPM ProFi decking is designed to be ultra low maintenance: no sanding, oiling or varnishing is needed. However, as with any outdoor flooring surface, periodic cleaning and correct care is needed to ensure that the deck retains its beauty for many years.

1. Ensuring that leaves and other debris are swept from the deck will minimise the need for deck washing.
2. Warm water and gentle brushing is often enough to clean away dust and debris. Normal household detergents can also be added to the water without damaging the decking.
3. A pressure washer is recommended for a more thorough cleaning. A narrow jet spray is most effective. To avoid damaging the deck surface, no more than 80 bar pressure must be used, and the nozzle must be kept at least 35 cm from the boards. The temperature of the water must not be higher than 40°C. The deck should first be sprayed with a detergent solution, then gently brushed, and finally rinsed with the spray.
4. Due to UPM ProFi deckings closed surface technology, oil and grease spills can normally be cleaned without staining. Such spills must be removed and the surface cleaned as soon as possible (ideally within 3 hours) with warm water and detergent. Should a grease stain remain, a household degreasing agent may be used to remove it. The deck should be thoroughly rinsed after cleaning with warm water. It is recommended to place a grill mat underneath a grill/barbecue.
5. Bleach and abrasive cleaning materials must not be used with UPM ProFi decking products.
6. For decks with a high level of traffic, such as commercial or public applications, regular inspections of the deck construction are recommended.

### Looks that last

Unlike many traditional WPC or timber decks, no UPM ProFi deck boards will suffer from the typical “wood greying” effect. When properly maintained, they will also avoid the stain marks and mould growth found on other decks. UPM ProFi Piazza is especially resistant to colour fading. UPM ProFi Deck 150 & Terra 127 will lighten gradually over time: cleaning with a pressure washer and brush will help to maintain the colour. In higher altitude locations, the stronger UV radiation may accelerate the natural weathering process. UPM ProFi Piazza and Deck 150 are recommended for such areas.

If dirt or debris is left lying on Deck 150 or Terra 127 for weeks at a time, it may result in discoloration.

**PLEASE NOTE**  
that with all UPM ProFi products:

In strong sunshine dark colour boards will reach higher temperatures than light colour boards. In such sunny and wind-protected locations, care should be taken to check the temperature of the boards before making direct skin contact: eg walking with bare feet.

As with all materials, light colours will show dirt more readily than darker colours and may therefore require more intensive cleaning.

Slight variations in colour shade may exist between different production batches.

Electrostatic charge may occur under certain circumstances. Advice on how to minimize it is included in the installation instructions.

Full information on how to install and care for UPM ProFi products can be found in the latest installation and cleaning & maintenance instructions at [www.upmprofi.com](http://www.upmprofi.com).

### Examples of typical colour change over time

UPM ProFi Deck 150 Autumn Brown and Pearl Grey

UPM ProFi Piazza Streaked Ebony

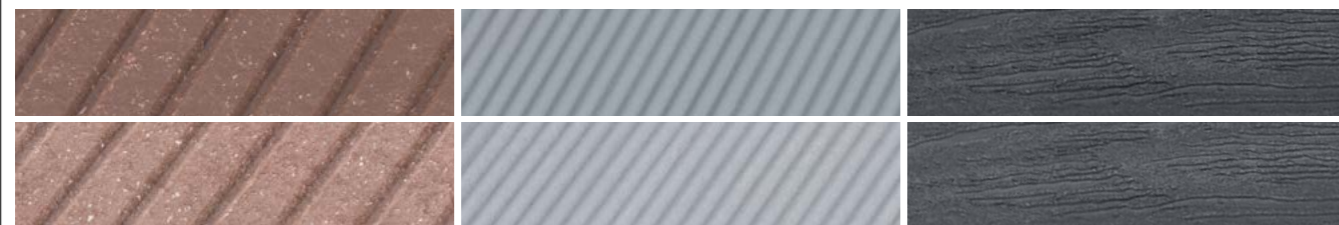

## Five steps to a perfect deck



### 1. Be inspired

Look through our collection of real life reference decks and stories.



### 2. Make a plan

Use our online Deck Planner to design the deck. You will receive a detailed material list and drawings.



### 3. Order a sample and find your nearest retailer

Get expert advice to help decide which products to buy.



### 4. Follow the instructions when installing

Whether you use a professional installer or build yourself, always follow the installation instructions and local building regulations.



### 5. Maintain your decking

UPM ProFi decks require very little maintenance, but follow the simple rules to maximize the deck life.



[www.upmprofi.com](http://www.upmprofi.com)

UPM Kymmene Corporation reserves the rights to change and amend the information in this brochure.  
The information contained in this document was correct at the time of publication. For the most update version, please visit [www.upmprofi.com](http://www.upmprofi.com).

PCAT EN 01 / 2024-English, Copyright UPM Biocomposites